

PROPRIETARY NOTICE
 INFORMATION DISCLOSED HEREIN IS THE PROPERTY OF CIES INCORPORATED. IT IS FURNISHED FOR EVALUATION PURPOSES ONLY AND SHALL NOT BE DISCLOSED OR USED FOR ANY OTHER PURPOSES EXCEPT AS SPECIFIED BY CONTRACT BETWEEN THE RECIPIENT AND CIES INCORPORATED. DUPLICATION OF ANY PORTION OF THIS DOCUMENT SHALL INCLUDE THIS NOTICE.

DWG NO. **CC2840330645** SH **1** REV. **-**

| REVISION HISTORY | | | |
|------------------|-----------------|------|-----------|
| REV | DESCRIPTION | DATE | APPROVED |
| - | INITIAL RELEASE | - | SEE BELOW |

| QTY | PART NUMBER | DESCRIPTION | MATERIAL/SPECIFICATON | WEIGHT | ZONE | ITEM |
|-----|----------------------------|--------------------------|-----------------------|--------|------|------|
| 2 | AN4-5 | BOLT | (10-32) | | | 5 |
| 9 | AN960 | WASHER | (#10) | | | 4 |
| 7 | MS20 365-1032 OR MS21042-3 | HEX NUT | (10-32) | | | 3 |
| 1 | CC2840450645-101 | ADAPTER BRACKET ASSEMBLY | | | | 2 |
| 1 | CC284022064X-101 | FUEL SENDER ASSEMBLY | | | | 1 |

PARTS LIST

CONTROLLED COPY

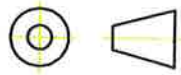
| | | | | |
|---|--------------------------------|-------------------------------|--|---|
| UNLESS OTHERWISE SPECIFIED DIMENSIONS ARE IN INCHES. TOLERANCES ARE: DECIMALS ANGLES X±.10 ±.5° .XX±.03 .XXX±.010 | CONTRACT NO. | |  1375 SE WILSON AVE. SUITE 150 BEND, OR 97702 | |
| | APPROVALS | DATE | | |
| | DO NOT SCALE DRAWING | DRAWN A FACKRELL | 2/4/2019 | INSTALLATION ASSEMBLY - CESSNA 414A & 421 |
| | THIRD ANGLE PROJECTION | CHECKED <i>[Signature]</i> | 2/22/19 | |
|  | ENGINEER <i>[Signature]</i> | 2/22/19 | | |
| | APPROVED <i>[Signature]</i> | 2/22/19 | SIZE B CAGE CODE 66YY1 DWG NO. CC2840330645 REV. - | |
| | | | SCALE NONE APPROVED FEB 22 2019 SHEET 1 OF 4 | |

4

3

1

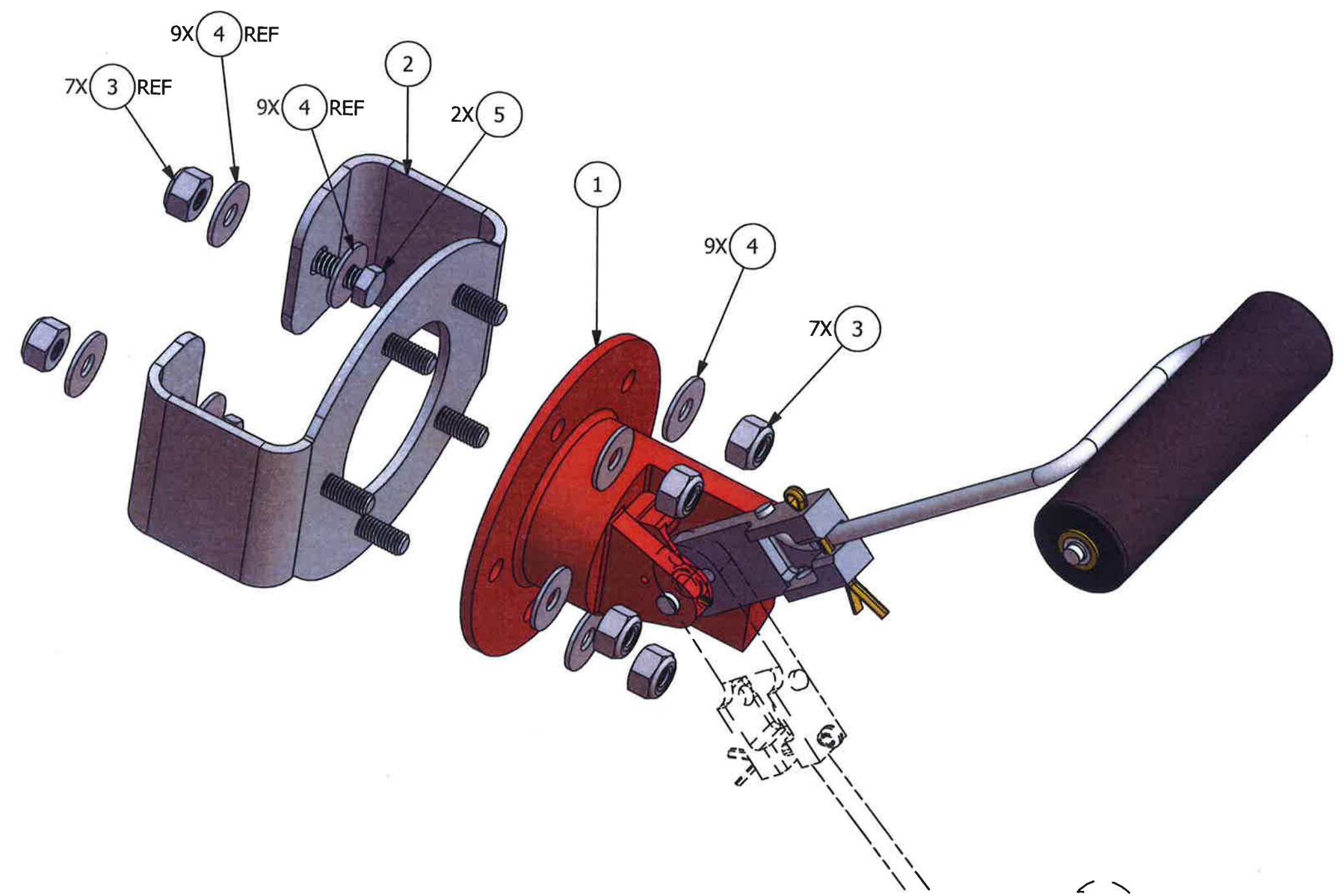

B

B

A

A

4

3

2

1

CONTROLLED COPY

| | | | |
|---|----------------------|---|--------------|
|  | | 1375 SE WILSON AVE SUITE 150 BEND, OR 97702 | |
| TITLE INSTALLATION ASSEMBLY - CESSNA 414A & 421 | | | |
| SIZE | CAGE CODE | DWG NO. | REV. |
| B | 66YY1 | CC2840330645 | - |
| SCALE | APPROVED FEB 22 2019 | | SHEET 2 OF 4 |
| 1 : 1 | | | 1 |

4

3

1

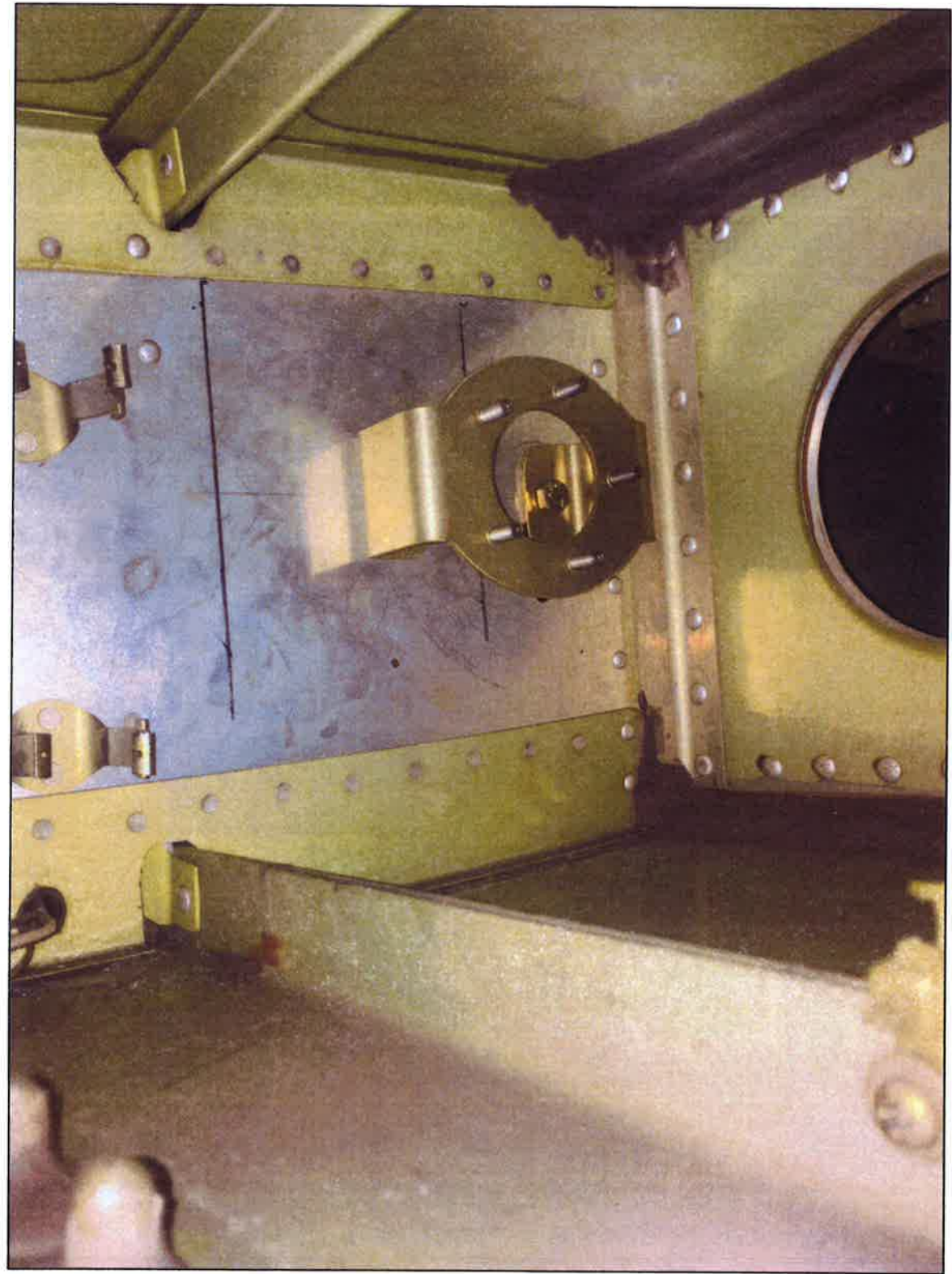

NOTES:

- 1) OPEN ACCESS PANEL TO REMOVE PENNY CAP PROBE AND GAIN ACCESS TO WING BAY.
- 2) SENDER BRACKET SHOULD BE POSITIONED MIDWAY BETWEEN THE STRINGER AND SPAR MIDWAY UP THE RIB. EXACT LOCATION IS NOT REQUIRED AS THE SENDER WILL ACCOMODATE.
- 3) DRILL THROUGH RIB FOR TWO AN3 BOLTS. F DRILL (0.250).
- 4) ATTACH BRACKET TO RIB USING AN3-5 BOLT, AN960 WASHER, MS20 365-1032 OR MS21042-3 NUT.
- 5) SPLICE SENDER WIRE HARNESS TO EXISTING AIRCRAFT WIRING HARNESS OR REPLACED WING HARNESS.
- 6) MOUNT SENDER TO BRACKET WITH WASHERS AND NUTS.
- 7) CHECK FOR CLEARANCE THROUGHOUT MOVEMENT RANGE EMPTY TO FULL.
- 8) RESEAL ACCESS PANEL.

CONTROLLED COPY

| | | | |
|--|--------------|---|--------------|
| | | 1375 SE WILSON AVE SUITE 150 BEND, OR 97702 | |
| TITLE | | | |
| INSTALLATION ASSEMBLY - CESSNA 414A & 421 | | | |
| SIZE | CAGE CODE | DWG NO. | REV. |
| B | 66YY1 | CC2840330645 | - |
| SCALE | | APPROVED FEB 22 2019 | SHEET 3 OF 4 |

4

3

2

1



IMAGE A



IMAGE B

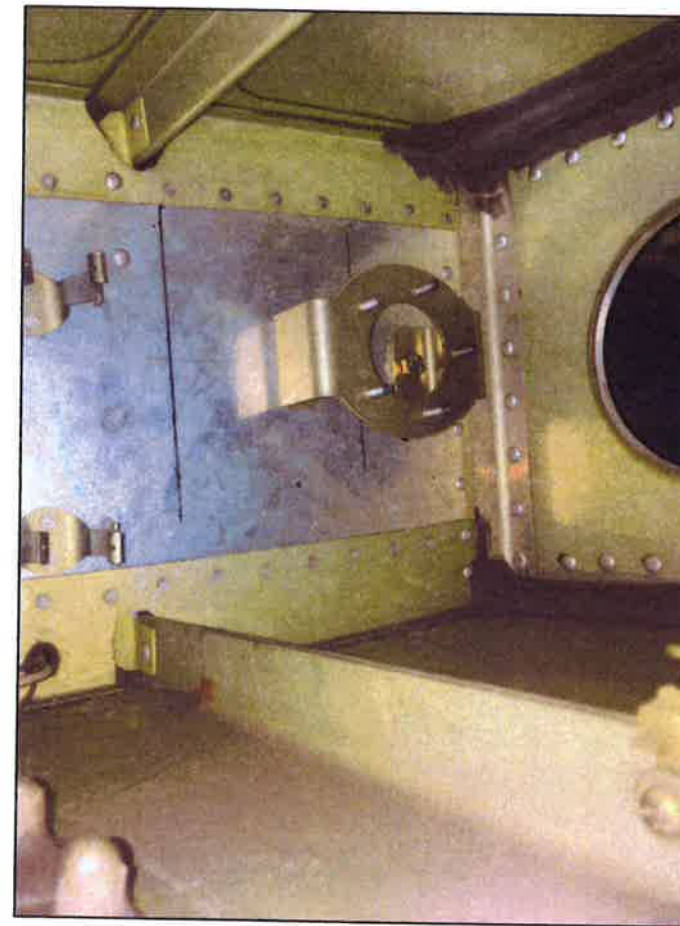

IMAGE C

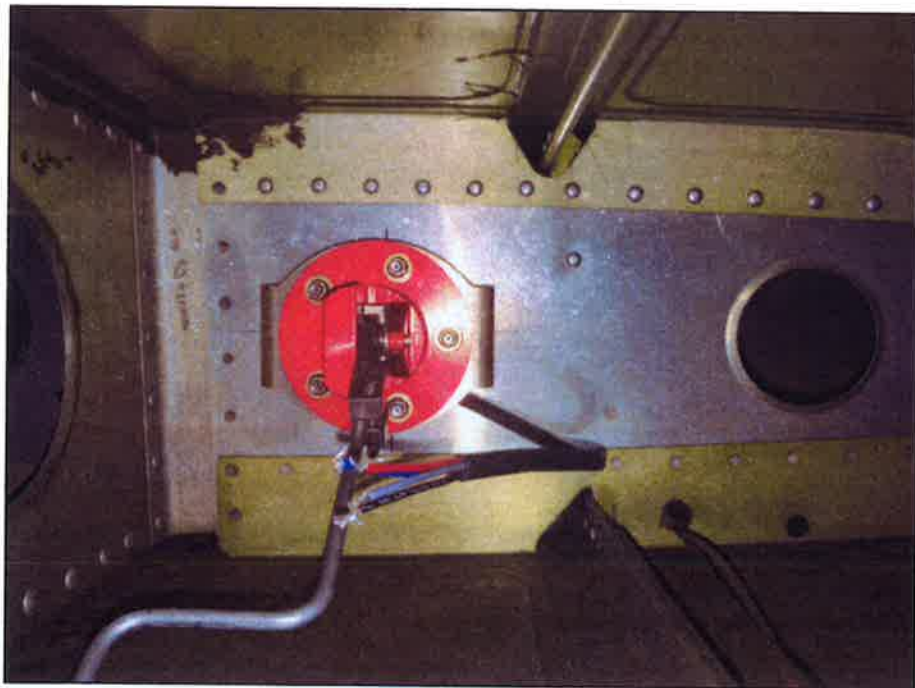

IMAGE D

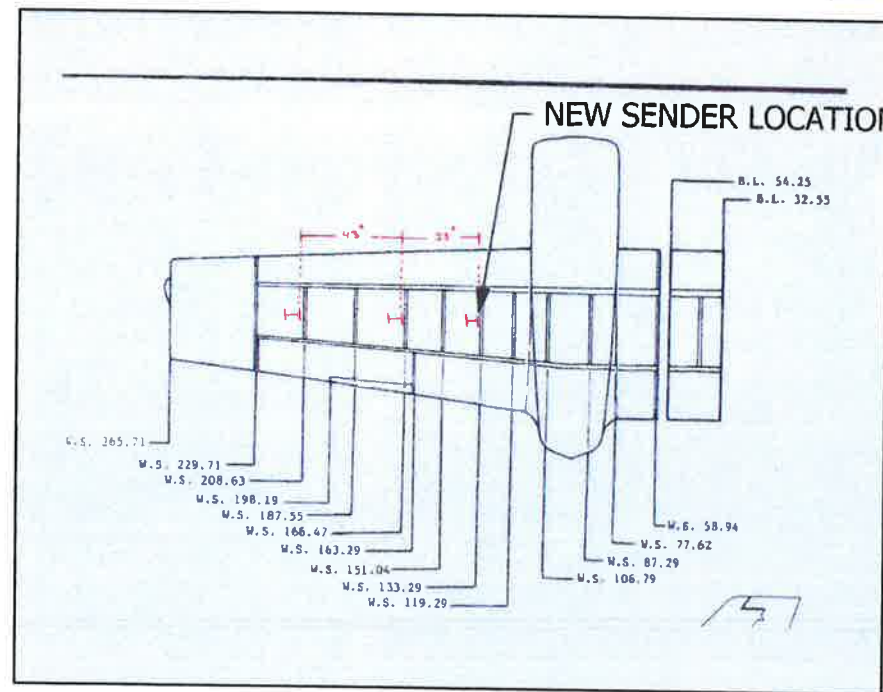

IMAGE E

CONTROLLED COPY

CIES INC 1375 SE WILSON AVE
SUITE 150
BEND, OR 97702

**INSTALLATION ASSEMBLY -
CESSNA 414A & 421**

| | | | |
|------------------|---------------------------|--------------------------------|------------------|
| SIZE B | CAGE CODE 66YY1 | DWG NO. CC2840330645 | REV. - |
| SCALE | | APPROVED FEB 22 2019 | |
| | | | SHEET 4 OF 4 |